

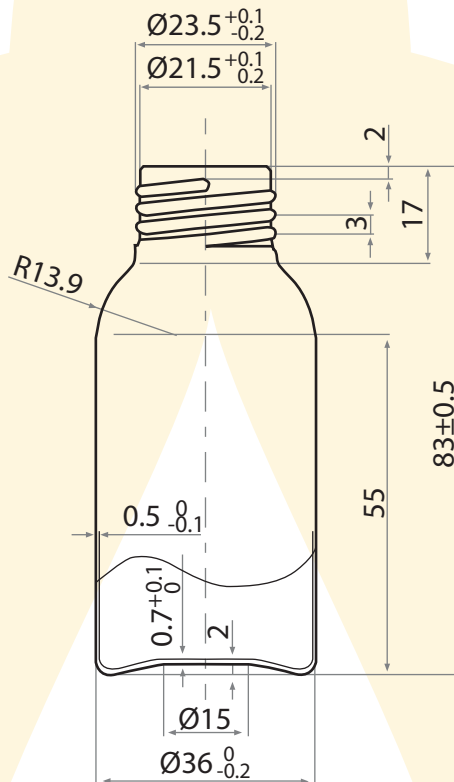

# NEW DIRECTIONS | AUSTRALIA

nda@newdirections.com.au | www.newdirections.com.au

47 CARRINGTON ROAD MARRICKVILLE, SYDNEY NSW 2204 AUSTRALIA | T: 612 8577 5999 | F: 612 8577 5977 | TOLL FREE: 1800 637 697



PRODUCT CODE	CMAB50
DESCRIPTION	50ml Aluminium Bottle
WIDTH	36mm $\pm 0.2$
HEIGHT	83mm $\pm 0.5$
NECK SIZE	24/410
MATERIAL	Aluminium
LINING	Cosmetic Grade Epoxy Resin Lining
WRAP AROUND LABEL*	Dimensions: W: 113mm x H: 51mm
BPA FREE	YES
RECYCLABLE	YES
NOTES	Caps are sold separately
DATE DRAWN	Feb/03/2016

Always store your packaging away from direct sunlight, at temperatures below 30°C  
Product compatibility testing is highly recommended when selecting (new) packaging.  
Always make sure you perform stability testing of your product in it's final packaging

*\*New Directions recommends testing the label size against physical sample of packaging prior to producing labels.*